

Owner's Manual

Thank you, and congratulations on your choice of BOSS RT-20 Rotary Sound Processor.

Before using this unit, carefully read the sections entitled: "USING THE UNIT SAFELY" and "IMPORTANT NOTES" (separate sheet).

These sections provide important information concerning the proper operation of the unit. Additionally, in order to feel assured that you have gained a good grasp of every feature provided by your new unit, this manual should be read in its entirety. The manual should be saved and kept on hand as a convenient reference.

Main Features

- COSM Modeling faithfully creates the speaker characteristics, internal cabinet resonance, rotation speed adjustments, and other particular elements of the rotary speaker to provide realistic reproduction of the rotary speaker sound.
- Includes overdrive, a must for rock sounds.
- Features four internal sounds, from the conventional rotary sound to rock sounds and UNI-V, a sound known and loved by many guitarists.
- Expression pedal can be used to freely control the rotation speed.
- Permits adjustment of the balance for the horn speaker and bass speaker volume levels, something difficult to accomplish with the original speakers. Use the knob to make changes in the tone, from sharp to mild, in real time.
- Features Virtual Rotor Display that displays the speaker rotation effectively as a visual image.

COSM (Composite Object Sound Modeling)

Composite Object Sound Modeling (COSM) is BOSS/Roland's innovative and powerful sound modeling technology.

COSM analyzes the many factors that make up the original sound, such as the electrical and physical characteristics of the original, and then produces a digital model that can reproduce the same sound.

Copyright © 2005 BOSS CORPORATION

All rights reserved. No part of this publication may be reproduced in any form without the written permission of BOSS CORPORATION.

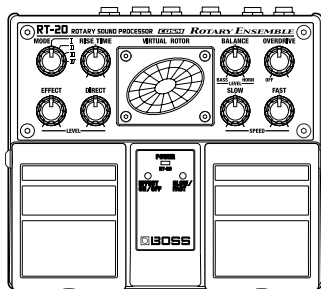

Contents

| | |
|--|-----------|
| Main Features | 1 |
| Installing Batteries | 3 |
| Making the Connections | 4 |
| Mono Connection | 5 |
| Stereo Connection..... | 6 |
| Operating the RT-20..... | 7 |
| Pedal Operation | 7 |
| Panel Operation | 8 |
| Adjusting the Balance of the HORN Rotor and BASS rotor volume | 9 |
| Adjusting the Rotor's Rotation Speed | 9 |
| Adjusting the Rate at Which the Speed Changes When Switching from SLOW to FAST and FAST to SLOW | 9 |
| Mixing the Direct Sound..... | 9 |
| Operating the SLOW /FAST Pedal..... | 9 |
| Operating the BRAKE..... | 10 |
| Controlling the RT-20 with an Expression Pedal..... | 10 |
| Names of Things and What They Do..... | 11 |
| Front Panel..... | 11 |
| Mode List | 13 |
| Rear Panel | 14 |
| Troubleshooting | 15 |
| Sample Settings | 16 |
| Setting Memo..... | 17 |
| Main Specifications | 18 |

Installing Batteries

Batteries are supplied with the unit. The life of these batteries may be limited, however, since their primary purpose was to enable testing.

Insert the included batteries as shown in figure, being careful to orient the batteries correctly.

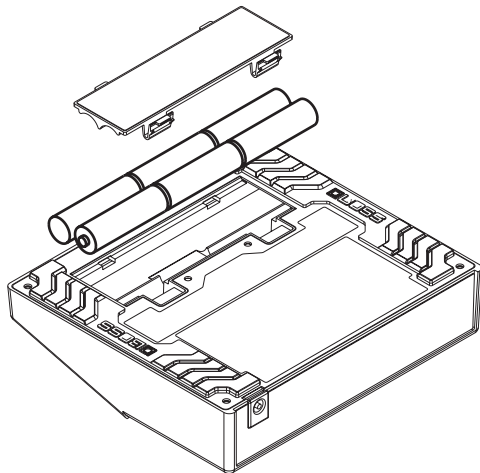

NOTE

- When turning the unit upside-down, get a bunch of newspapers or magazines, and place them under the four corners or at both ends to prevent damage to the buttons and controls. Also, you should try to orient the unit so no buttons or controls get damaged.
- When turning the unit upside-down, handle with care to avoid dropping it, or allowing it to fall or tip over.
- Make sure the "+" and "-" ends of the batteries are oriented correctly.
- When the batteries run down, the POWER indicator gets dim. If this happens, replace with new batteries.
- When replacing the batteries, use six AA type.
- Avoid using new batteries together with used ones. In addition, avoid mixing different types of batteries. Doing so can result in fluid leakage.
- Battery life can vary depending on battery type.

MEMO

Continuous usage time under battery power is about 10 hours with alkaline batteries and about 6 hours with carbon batteries. (This may vary according to usage conditions.)

Making the Connections

NOTE

- The use of an AC adaptor is recommended as the unit's power consumption is relatively high. Should you prefer to use batteries, please use the alkaline type.
- Noise may be produced if wireless communications devices, such as cell phones, are operated in the vicinity of this unit. Such noise could occur when receiving or initiating a call, or while conversing. Should you experience such problems, you should relocate such wireless devices so they are at a greater distance from this unit, or switch them off.
- Use a cable from Roland to make the connection. If using some other make of connection cable, please note the following precautions.
 - Some connection cables contain resistors. Do not use cables that incorporate resistors for connecting to this unit. The use of such cables can cause the sound level to be extremely low, or impossible to hear. For information on cable specifications, contact the manufacturer of the cable.
- When the unit is running on battery power, the power comes on when you insert the connector plug into the INPUT A (MONO) jack.
- To prevent malfunction and/or damage to speakers or other devices, always turn down the volume, and turn off the power on all devices before making any connections.
- If there are batteries in the unit while an AC adaptor is being used, normal operation will continue should the line voltage be interrupted (power blackout or power cord disconnection).
- Once the connections have been completed, turn on power to your various devices in the order specified. By turning on devices in the wrong order, you risk causing malfunction and/or damage to speakers and other devices.

When powering up: Turn on the power to your guitar amp **last**.

When powering down: Turn off the power to your guitar amp **first**.
- Always make sure to have the volume level turned down before switching on power. Even with the volume all the way down, you may still hear some sound when the power is switched on, but this is normal, and does not indicate a malfunction.
- When operating on battery power only, the POWER indicator will become dim when battery power gets too low. Replace the battery as soon as possible.
- When moved from one location to another where the temperature and/or humidity is very different, water droplets (condensation) may form inside the unit. Damage or malfunction may result if you attempt to use the unit in this condition. Therefore, before using the unit, you must allow it to stand for several hours, until the condensation has completely evaporated.

Mono Connection

■ Guitar

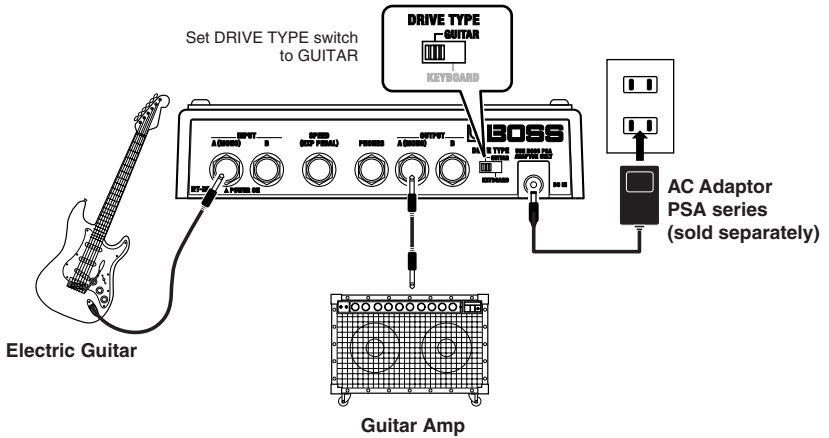

■ Keyboard

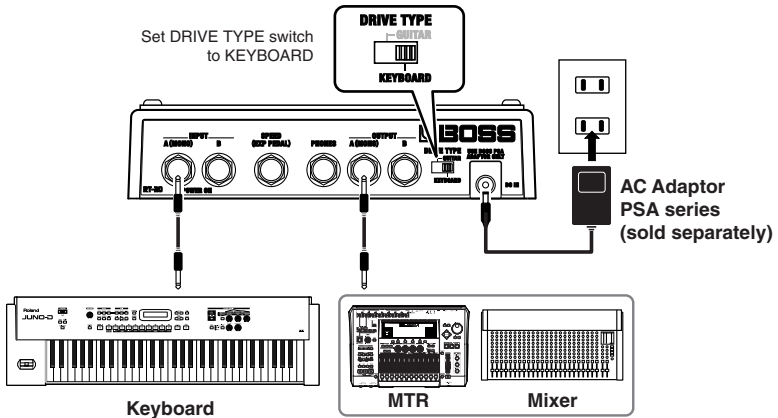

Stereo Connection

■ Guitar

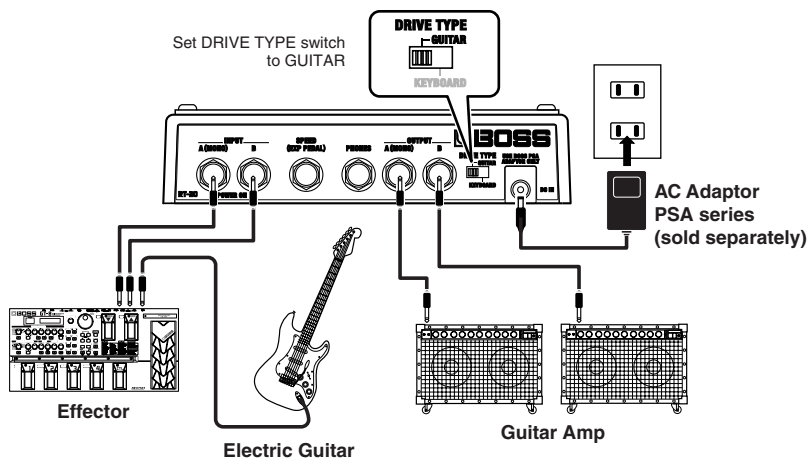

■ Keyboard

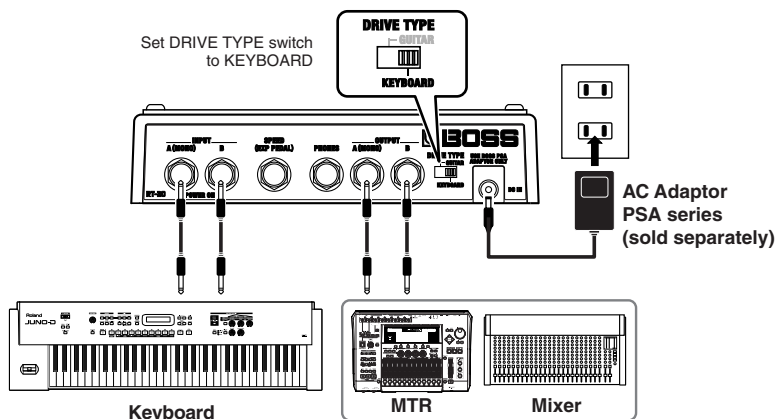

Operating the RT-20

Pedal Operation

When "ON"



When "OFF"



When set to "SLOW"



When set to "FAST"

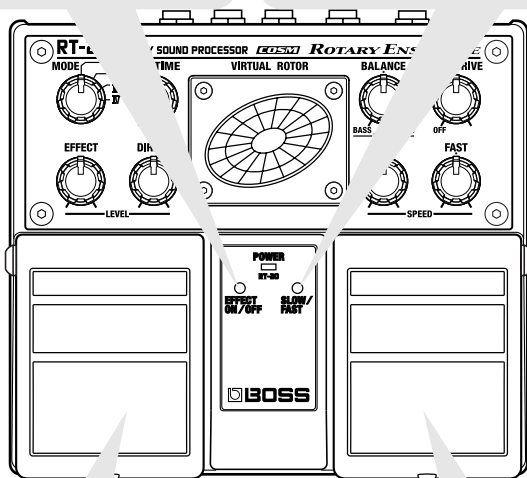

EFFECT ON/OFF Pedal

Alternately switches the effect on or off each time the pedal is pressed.

When switched off, the sound input to the INPUT jack is output without change.

SLOW/FAST Pedal

Switches the rotor's rotation speed each time the pedal is pressed.

Panel Operation

For this description of using the pedals, first press the EFFECT ON/OFF pedal to switch on the effect (ON/OFF indicator lit), and press the SLOW/FAST pedal to switch the setting to SLOW (SLOW/FAST indicator off).

In addition, set the knobs to the positions shown in the figure.

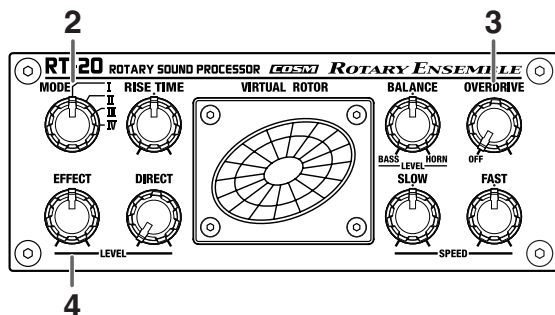

1. Set the DRIVE TYPE switch on the rear panel to match the type of instrument being used.
Refer to "Making the Connections" (p. 5–p. 6).
2. Use the MODE knob to select the desired rotary speaker effect from the four types.
3. Turn the OVERDRIVE knob to adjust the amount of drive applied.
4. Adjust the EFFECT ON volume by turning the EFFECT LEVEL knob.

While the settings described above produce a rotary speaker sound, The RT-20 allows you to control the following factors that are difficult to control with conventional rotary speakers.

- Adjust the balance of the HORN rotor and BASS rotor volume
- Adjust the rotor's rotation speed
- Adjust the rate at which the speed changes when switching from SLOW to FAST and FAST to SLOW
- Mix the direct sound

Adjusting the Balance of the HORN Rotor and BASS rotor volume

You can adjust the balance in volume from the horn rotor and bass rotor inside the rotary speaker with the BALANCE knob.



Adjusting the Rotor's Rotation Speed

You can adjust the rotor rotation speed using the SLOW SPEED and FAST SPEED knobs.

Turning these knobs to the center position sets the rotor speed to the standard rotation speed.

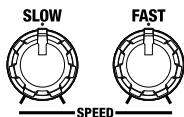

Adjusting the Rate at Which the Speed Changes When Switching from SLOW to FAST and FAST to SLOW

You can adjust the rate at which the rotation changes from slow to fast and vice versa with the RISE TIME knob.

Turn the knob to the left to slow down the rate of change; turn the knob to the right to increase the rate.

When this knob is at the center position, the rise time is set to the standard setting.



Mixing the Direct Sound

If you want to retain the nuance of the direct sound used by the guitar or other instrument, you can add the direct sound using the DIRECT knob.

** If you want to reproduce the regular rotary speaker sound, turn this knob completely to the left to shut off the direct sound.*

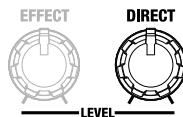

Operating the SLOW/FAST Pedal

You can switch the rotor's rotation speed by pressing the SLOW/FAST pedal.

When set to SLOW, the SLOW/FAST indicator is switched off; the indicator is lit when the speed is set to FAST.

Operating the BRAKE

You can use the brake to stop the rotation of the rotor.

Pressing both of the pedals simultaneously stops the rotation of the rotor.

The SLOW/FAST indicator flashes rapidly while the brake is on.

The time required for the rotor to come to a stop after the BRAKE is activated changes according to the position of the RISE TIME knob.

The time required for the rotor to stop increases as the knob is turned further left from the center position; turning the knob to the right of the center position decreases the time required for the rotor to stop.

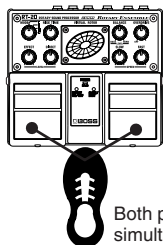

Both pressed
simultaneously



To cancel the BRAKE, pressing either the light pedal or both left and right pedals simultaneously.

The rotor always faces directly in front when stopped.

Controlling the RT-20 with an Expression Pedal

You can connect an optional expression pedal (such as the Roland EV-5) to the rear panel SPEED (EXP PEDAL) jack and use the pedal to control the rotor's rotation speed in real time.

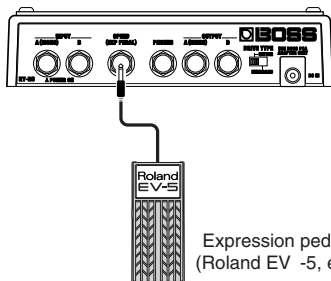

With the expression pedal fully released, the RT-20 switches to the value set with the SLOW SPEED knob; depressing the pedal all the way switches the RT-20 to the value set with the FAST SPEED knob.

- * The SLOW/FAST indicator flashes when an expression pedal is connected.
- * Operation of the SLOW/FAST pedal is disabled while the expression pedal is connected.
- * You can also use an expression pedal to operate the BRAKE.
- * Use only the specified expression pedal (EV-5; sold separately). By connecting any other expression pedals, you risk causing malfunction and/or damage to the unit.

Names of Things and What They Do

Front Panel

RISE TIME Knob

This adjusts the rate at which the rotation changes from slow to fast and vice versa. When this knob is at the center position, the rotary speaker rotation changes at the standard rate.

MODE Knob

Use this to select the rotary speaker effect from the four available types.

☞ “Mode List” (p. 13)

BALANCE Knob

This adjusts the balance in volume from the horn rotor and bass rotor inside the rotary speaker with the BALANCE knob.

* When MODE is set to IV, this knob adjusts the intensity of the UNI-V effect.

OVERDRIVE Knob

This knob adjusts the depth of the overdrive effect. Switch to OFF when overdrive is not being used.

EFFECT LEVEL Knob

This adjusts the volume level of the effect sound.

DIRECT LEVEL Knob

This adjusts the volume level of the direct sound.

* If you want to reproduce the regular rotary speaker sound, turn this knob completely to the left to shut off the direct sound.

FAST SPEED Knob

This adjusts the rotor's rotation speed when FAST is selected. When the knob is at the center position, it sets the rotor's rotation speed to the standard rotation speed.

SLOW SPEED Knob

This adjusts the rotor's rotation speed when SLOW is selected. When the knob is at the center position, it sets the rotor's rotation speed to the standard rotation speed. Turn the knob completely to the left to have the rotor facing directly toward the front when stopped.

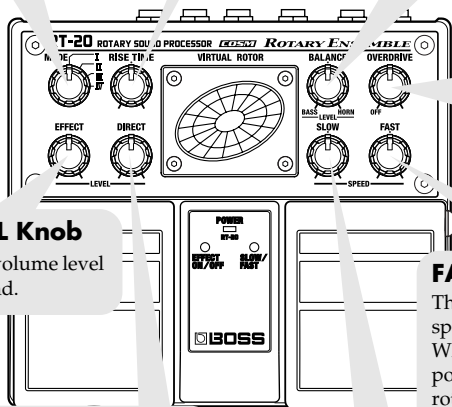

VIRTUAL ROTOR Display

This display uses indicators and moving light beams to indicate the rotary speaker effect visually. The HORN rotor is indicated with the red light, the BASS rotor with blue.

EFFECT ON/OFF Indicator

This lights up when the effect is on.

SLOW/FAST Indicator

Extinguished when SLOW is selected; lights when FAST is selected.

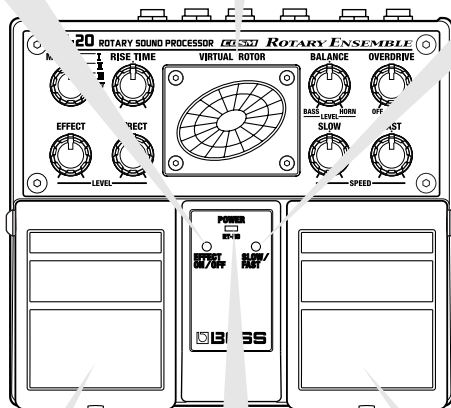

POWER Indicator

This lights up when the power is on.

EFFECT ON/OFF Pedal

This alternately switches the effect on or off each time the pedal is pressed. When switched off, the sound input to the INPUT jack is output without change.

SLOW/FAST Pedal

This alternately switches the rotor's rotation speed to FAST or SLOW each time the pedal is pressed.

Mode List

The rotary speaker sound is modeled on the famed vintage Leslie 122 speaker.

The MODE knob is used to switch between the rotary and overdrive tones.

* *The trademarks listed in this document are trademarks of their respective owners, which are separate companies from BOSS. Those companies are not affiliated with BOSS and have not licensed or authorized BOSS's RT-20. Their marks are used solely to identify the equipment whose sound is simulated by BOSS's RT-20.*

| Mode | Descriptions |
|-------------|---|
| I | Combination of standard Leslie 122 sound and natural overdrive. This is the mode with the broadest range of uses. |
| II | Combination of Leslie 122 with on-mic setting and natural overdrive. This produces a sound with an emphasized sense of tremolo. |
| III | This mode combines the sound of the Leslie 122 with the distortion of a Marshall 1959. This is a whole new sound, unavailable with any regular system, with a particularly intense distortion. |
| IV | This sound combines the UNI-V, modeled on the "Uni Vibe" effect, which recalls the late '60s and the '70s, together with the Marshall 1959. The intensity of the UNI-V effect is adjusted with the BALANCE knob. |

Rear Panel

INPUT Jacks (INPUT A (MONO), INPUT B)

These input jacks are used for connecting electric guitars, keyboards, other instruments, and effects processors.

Connect mono instruments or effects to the A (MONO) jack.

☞ “Making the Connections” (p. 4)

* *The A (MONO) jack also doubles as the power switch when the unit is running on battery power. The power comes on when a plug is inserted into the A (MONO) jack, and goes off when it is unplugged. Unplug any connected cords when the unit is not in use.*

Headphone Jack (PHONES)

You can listen through headphones by connecting the headphones here.

* *Plug in the headphones only after turning on the power. When turning the power off, unplug the headphones first, and then turn off the power.*

DRIVE TYPE Switch

This sets the overdrive gain to levels appropriate for guitars or for keyboards.

Set the switch according to the type of instrument you are connecting.

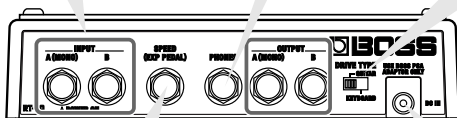

SPEED (EXP PEDAL) Jack

Connect an optional expression pedal (such as the Roland EV-5) to this jack.

You can use the connected pedal to control the rotor's rotation speed in real time.



“Controlling the RT-20 with an Expression Pedal” (p. 10)

AC Adaptor Jack (DC IN)

This jack is for connecting an AC adaptor (BOSS PSA-series, sold separately).

Using an AC adaptor makes possible long performances with no worry about batteries going dead.

OUTPUT Jacks (OUTPUT A (MONO), OUTPUT B)

Use these jacks to connect to a guitar amp or keyboard amp or to an effects processor, mixer, multitrack recorder, or other such device.

Connect to the A (MONO) jack when outputting in mono.

☞ “Making the Connections” (p. 4)

Troubleshooting

The power doesn't come on.

- **Is the guitar or keyboard connected correctly to the INPUT A (MONO) jack?**

→ Check the connections again (p. 4–p. 6).

* *When running off batteries, the unit won't switch on unless there's something plugged into the INPUT jack. This helps conserve the batteries.*

- **Is the plug connected to the INPUT B jack?**

→ When using battery power, connect the plug to the INPUT A (MONO) jack.

- **Have the batteries run down?**

→ Replace with fresh batteries (p. 3).

- **Is the specified AC adaptor (PSA-series sold separately) connected correctly?**

→ Check the connections again (p. 5–p. 6).

There is no sound.

- **Is the other equipment connected correctly?**

→ Check the connections again (p. 5–p. 6).

- **Is the volume turned down on the connected guitar/keyboard, effects processor, or other device?**

→ Check the settings on the connected equipment (p. 4–p. 6).

- **Is the effect level (EFFECT LEVEL knob) set to minimum?**

→ Operate the EFFECT LEVEL knob to adjust the effect level (p. 8).

Sound is distorted.

- **Are the EFFECT LEVEL knob and DIRECT LEVEL knob positioned correctly?**

→ Sounds may become distorted with the knob at certain settings. Turn down the EFFECT LEVEL knob and DIRECT LEVEL knob to appropriate level. If in spite of these measures the sound is still distorted, lower the output level of the device connected to the INPUT jacks.

The volume level of the instrument connected to INPUT jack is too low.

- **Could you be using a connection cable that contains a resistor?**

→ Use a connection cable that does not contain a resistor.

Sample Settings

* Set the DRIVE TYPE switch on the rear panel to match the type of instrument being used.

■ STANDARD SOUND

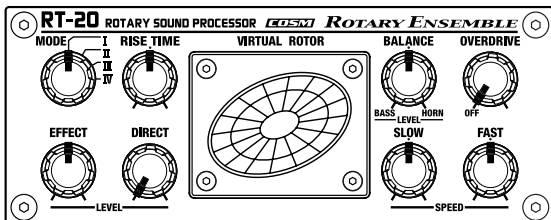

■ TREMOLO CHORUS

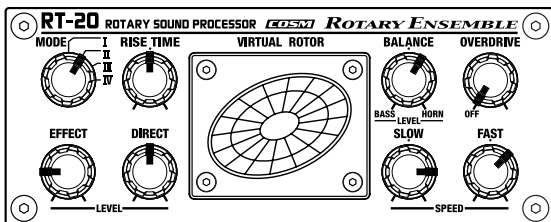

■ WILD SPIN

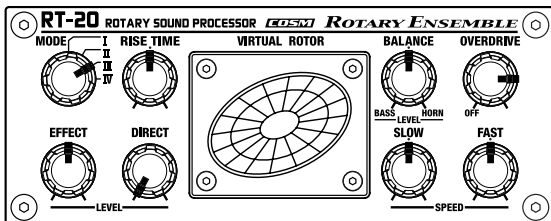

■ UNI-V

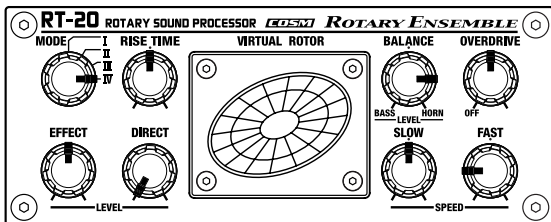

Setting Memo

.....
.....
.....
.....
.....
.....
.....

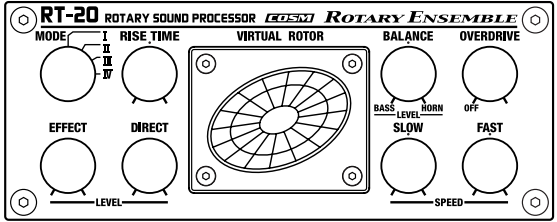

.....
.....
.....
.....
.....
.....
.....

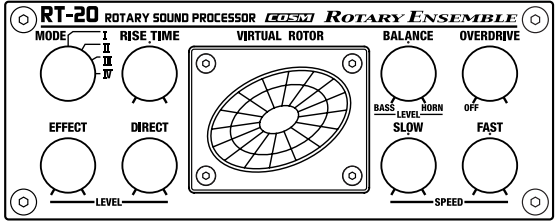

.....
.....
.....
.....
.....
.....
.....

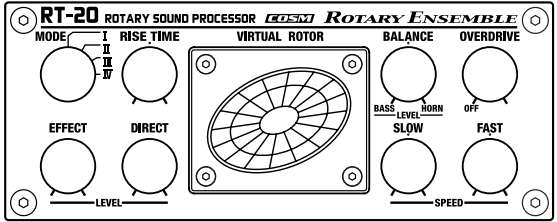

.....
.....
.....
.....
.....
.....
.....

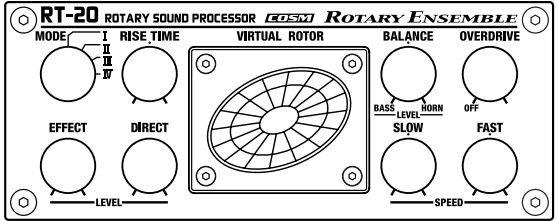

Main Specifications

RT-20: Rotary Sound Processor

Nominal Input Level

-20 dBu

Input Impedance

1 M Ω

Output Impedance

1 k Ω

Recommended Load Impedance

10 k Ω or greater

Display

VIRTUAL ROTOR

Controls

EFFECT ON/OFF pedal

SLOW/FAST pedal

OVERDRIVE knob

BALANCE knob

RISE TIME knob

MODE knob

FAST SPEED knob

SLOW SPEED knob

DIRECT LEVEL knob

EFFECT LEVEL knob

DRIVE TYPE switch

Indicators

POWER indicator

(serves also as battery check indicator)

EFFECT ON/OFF indicator

SLOW/FAST indicator

Connectors

INPUT A (MONO) jack (1/4 inch phone type)

INPUT B jack (1/4 inch phone type)

SPEED (EXP PEDAL) jack (stereo 1/4 inch phone type)

PHONES jack (stereo 1/4 inch phone type)

OUTPUT A (MONO) jack (1/4 inch phone type)

OUTPUT B jack (1/4 inch phone type)

AC Adaptor jack

Power Supply

DC 9 V: Dry battery (R6/LR6 (AA) type) x 6,
AC Adaptor

Current Draw

85 mA (9 V max.)

* *Expected battery life under continuous use:*

Carbon: 6 hours

Alkaline: 10 hours

These figures will vary depending on the actual conditions of use.

Dimensions

173 (W) x 158 (D) x 57 (H) mm

6-13/16 (W) x 6-1/4 (D) x 2-1/4 (H) inches

Weight

1.1 kg / 2 lbs 7 oz (including batteries)

Accessories

Owner's Manual

Leaflet ("USING THE UNIT SAFELY,"

"IMPORTANT NOTES," and "Information")

Dry battery (R6 (AA) type) x 6

* *We recommend that alkaline batteries be used when replacing the batteries.*

Options

AC Adaptor (PSA-series)

Expression Pedal (Roland EV-5)

* $0 \text{ dBu} = 0.775 \text{ Vrms}$

NOTE

In the interest of product improvement, the specifications and/or appearance of this unit are subject to change without prior notice.



This product complies with the requirements of European Directive 89/336/EEC.

For EU Countries

FEDERAL COMMUNICATIONS COMMISSION RADIO FREQUENCY INTERFERENCE STATEMENT

For the USA

This equipment has been tested and found to comply with the limits for a Class B digital device, pursuant to Part 15 of the FCC Rules. These limits are designed to provide reasonable protection against harmful interference in a residential installation. This equipment generates, uses, and can radiate radio frequency energy and, if not installed and used in accordance with the instructions, may cause harmful interference to radio communications. However, there is no guarantee that interference will not occur in a particular installation. If this equipment does cause harmful interference to radio or television reception, which can be determined by turning the equipment off and on, the user is encouraged to try to correct the interference by one or more of the following measures:

- Reorient or relocate the receiving antenna.
- Increase the separation between the equipment and receiver.
- Connect the equipment into an outlet on a circuit different from that to which the receiver is connected.
- Consult the dealer or an experienced radio/TV technician for help.

This device complies with Part 15 of the FCC Rules. Operation is subject to the following two conditions:

- (1) This device may not cause harmful interference, and
- (2) This device must accept any interference received, including interference that may cause undesired operation.

Unauthorized changes or modification to this system can void the users authority to operate this equipment.
This equipment requires shielded interface cables in order to meet FCC class B Limit.

For Canada

NOTICE

This Class B digital apparatus meets all requirements of the Canadian Interference-Causing Equipment Regulations.

AVIS

Cet appareil numérique de la classe B respecte toutes les exigences du Règlement sur le matériel brouilleur du Canada.

* This device features light emitting diodes (LEDs), which with certain settings may repeatedly flash on and off at a rapid rate. Some persons may experience headaches or nausea by staring at such flashing lights. Cease looking at the LEDs immediately if this occurs.

